

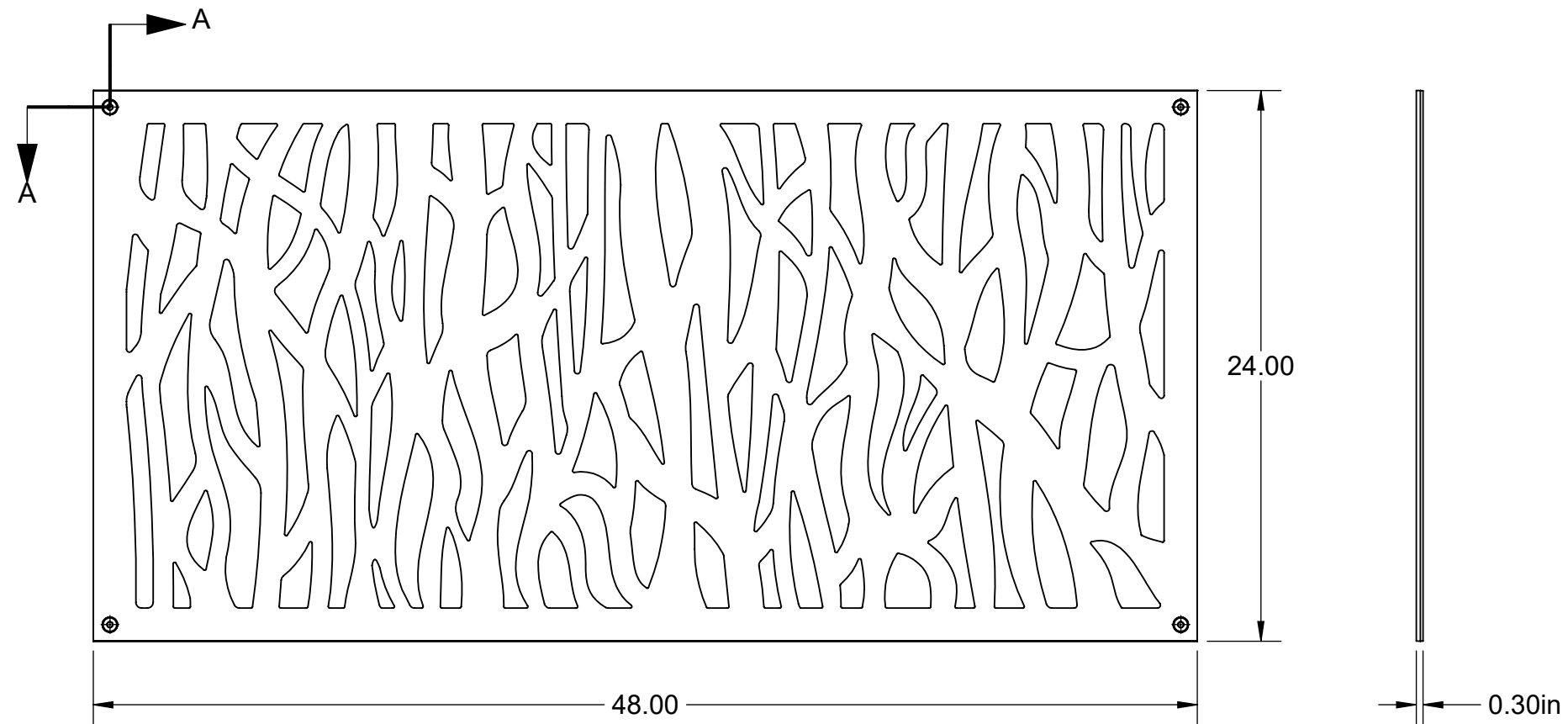

SPRIG DECORATIVE SCREEN PANEL DETAILS

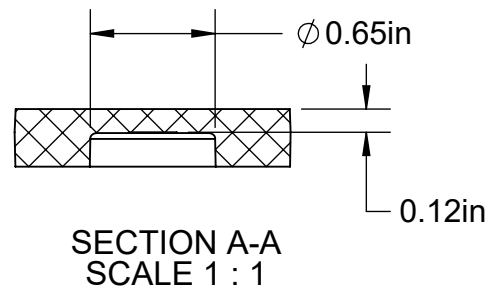

THE INFORMATION CONTAINED IN THIS DRAWING IS PROTECTED BY COPYRIGHT AND PATENT LAWS OF THE UNITED STATES AND OTHER COUNTRIES. ANY REPRODUCTION IN PART OR AS A WHOLE WITHOUT WRITTEN PERMISSION IS PROHIBITED.

		BARRETTE Outdoor Living	
DRAWN:	RP	DATE:	10/15/2018
DESCRIPTION:			
SPRIG DECORATIVE SCREEN PANEL 2'X4'			
SHEET 1 OF 7	REVISION	PART NUMBER	N/A
SCALE 1:7	0		
WEIGHT: 9.17			

REV	BY	DATE	PCR	DESCRIPTION

BOARDWALK DECORATIVE SCREEN PANEL DETAILS

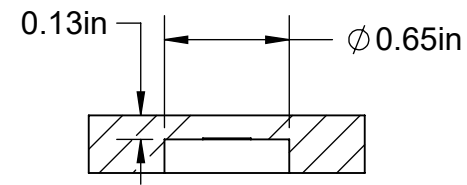

SECTION B-B
SCALE 1 : 1

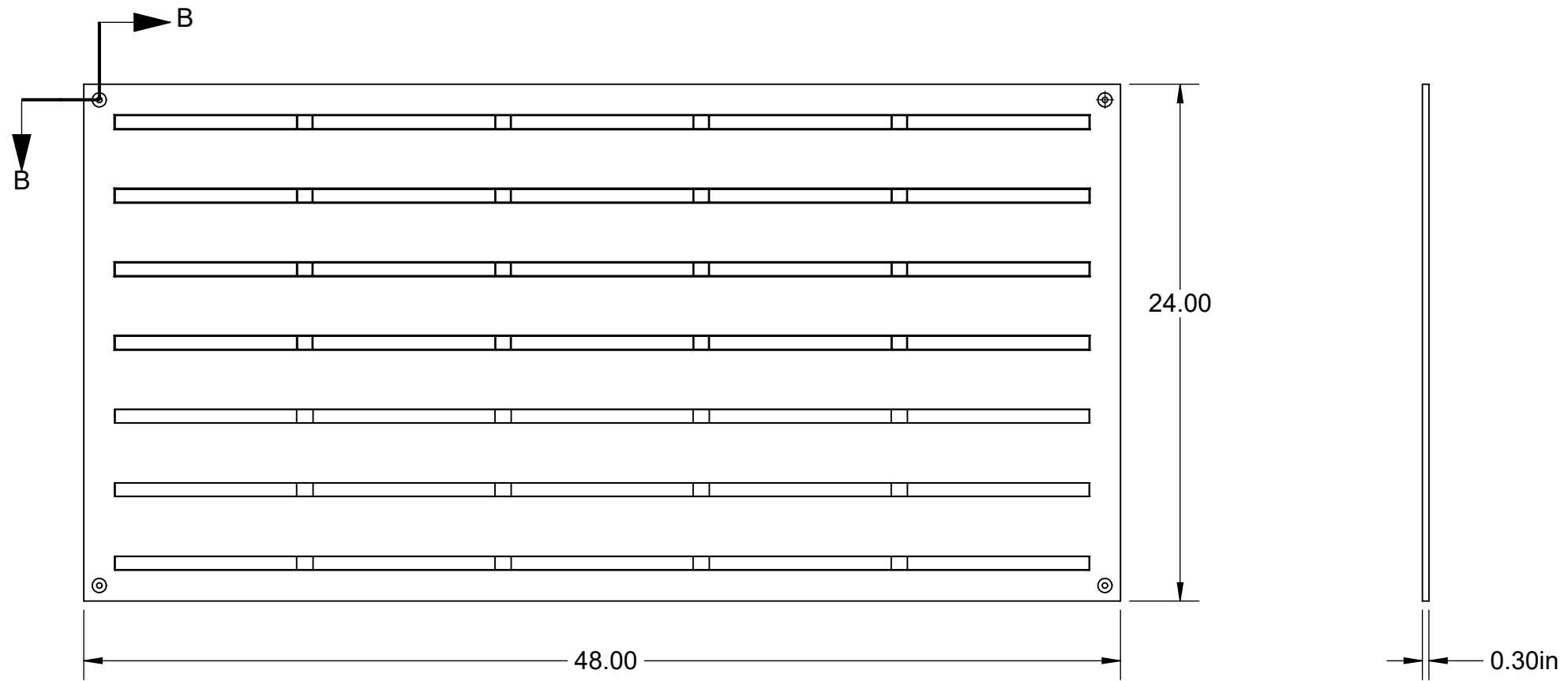

THE INFORMATION CONTAINED IN THIS DRAWING IS PROTECTED BY COPYRIGHT AND PATENT LAWS OF THE UNITED STATES AND OTHER COUNTRIES. ANY REPRODUCTION IN PART OR AS A WHOLE WITHOUT WRITTEN PERMISSION IS PROHIBITED.

		BARRETTE Outdoor Living
DRAWN: RP	DATE: 10/16/2018	APPROVED:
DESCRIPTION: BOARDWALK DECORATIVE SCREEN PANEL 2'X4'		
SHEET 2 OF 7	REVISION	PART NUMBER
SCALE 1:7		N/A
WEIGHT:		

BUNGALOW DECORATIVE SCREEN PANEL DETAILS

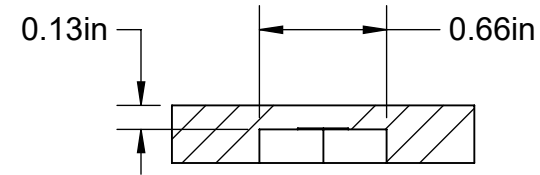

SECTION C-C
SCALE 1 : 1

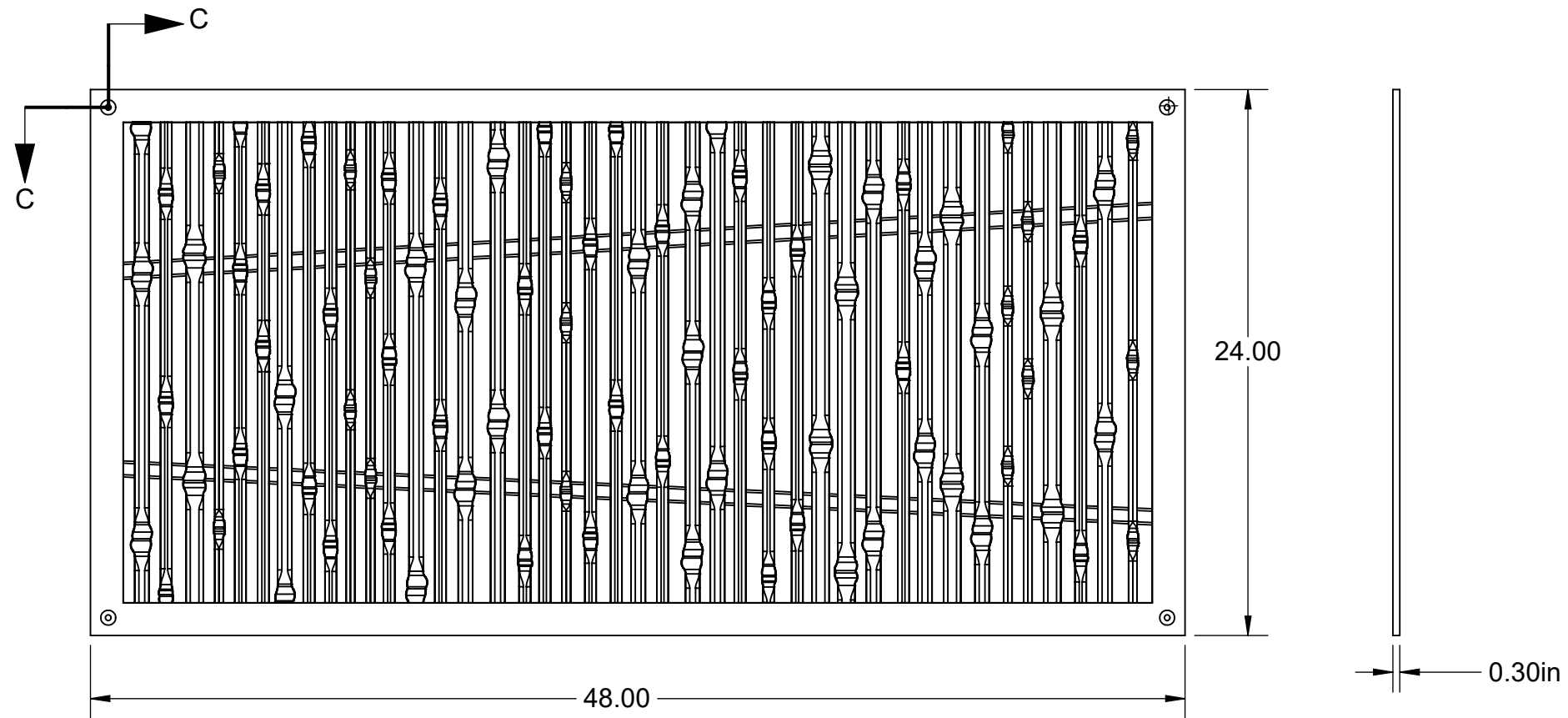

THE INFORMATION CONTAINED IN THIS DRAWING IS PROTECTED BY COPYRIGHT AND PATENT LAWS OF THE UNITED STATES AND OTHER COUNTRIES. ANY REPRODUCTION IN PART OR AS A WHOLE WITHOUT WRITTEN PERMISSION IS PROHIBITED.

		BARRETTE Outdoor Living
DRAWN: RP	DATE: 10/16/2018	APPROVED:
DESCRIPTION: BUNGALOW DECORATIVE SCREEN PANEL 2'X4'		
SHEET 3 OF 7	REVISION	PART NUMBER
SCALE 1:7	0	N/A
WEIGHT: 5.383		

CELTIC DECORATIVE SCREEN PANEL DETAILS

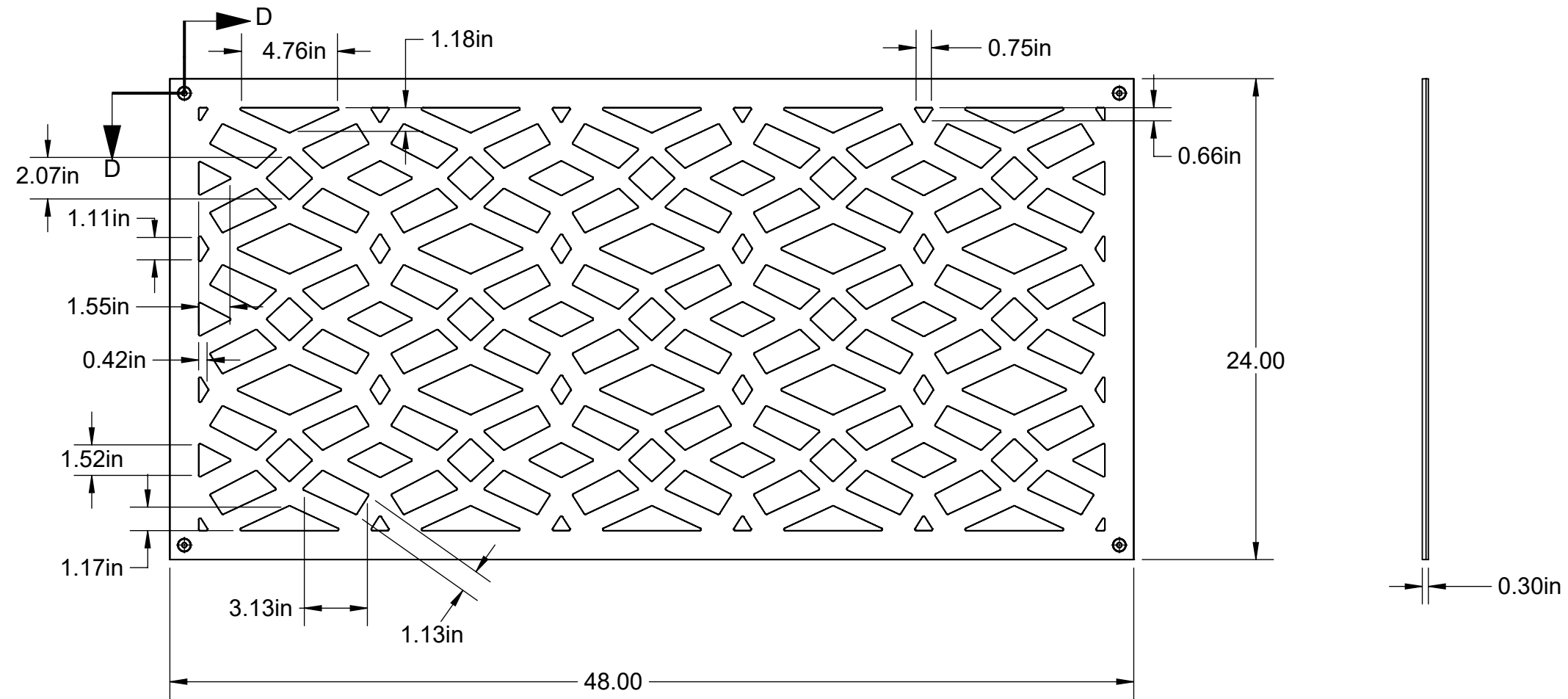
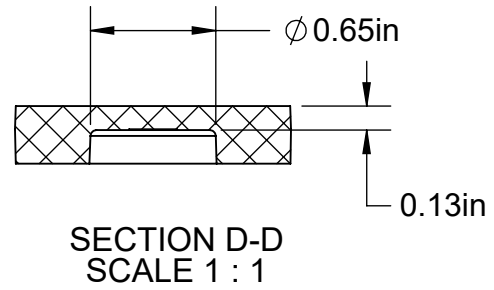

THE INFORMATION CONTAINED IN THIS DRAWING IS PROTECTED BY COPYRIGHT AND PATENT LAWS OF THE UNITED STATES AND OTHER COUNTRIES. ANY REPRODUCTION IN PART OR AS A WHOLE WITHOUT WRITTEN PERMISSION IS PROHIBITED.

		BARRETTE Outdoor Living
DRAWN: RP	DATE: 10/16/2018	APPROVED:
DESCRIPTION: CELTIC DECORATIVE SCREEN PANEL 2'X4'		
SHEET 4 OF 7	REVISION	PART NUMBER
SCALE 1:7	0	N/A
WEIGHT: 8.70		

MORSE DECORATIVE SCREEN PANEL DETAILS

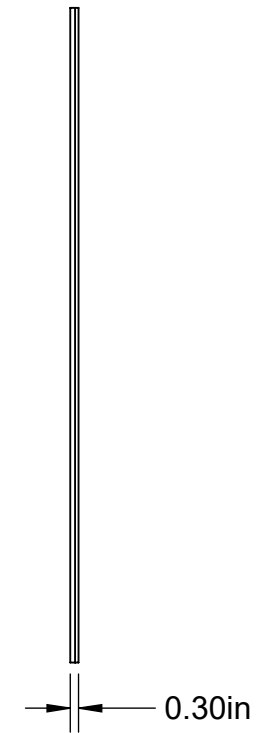
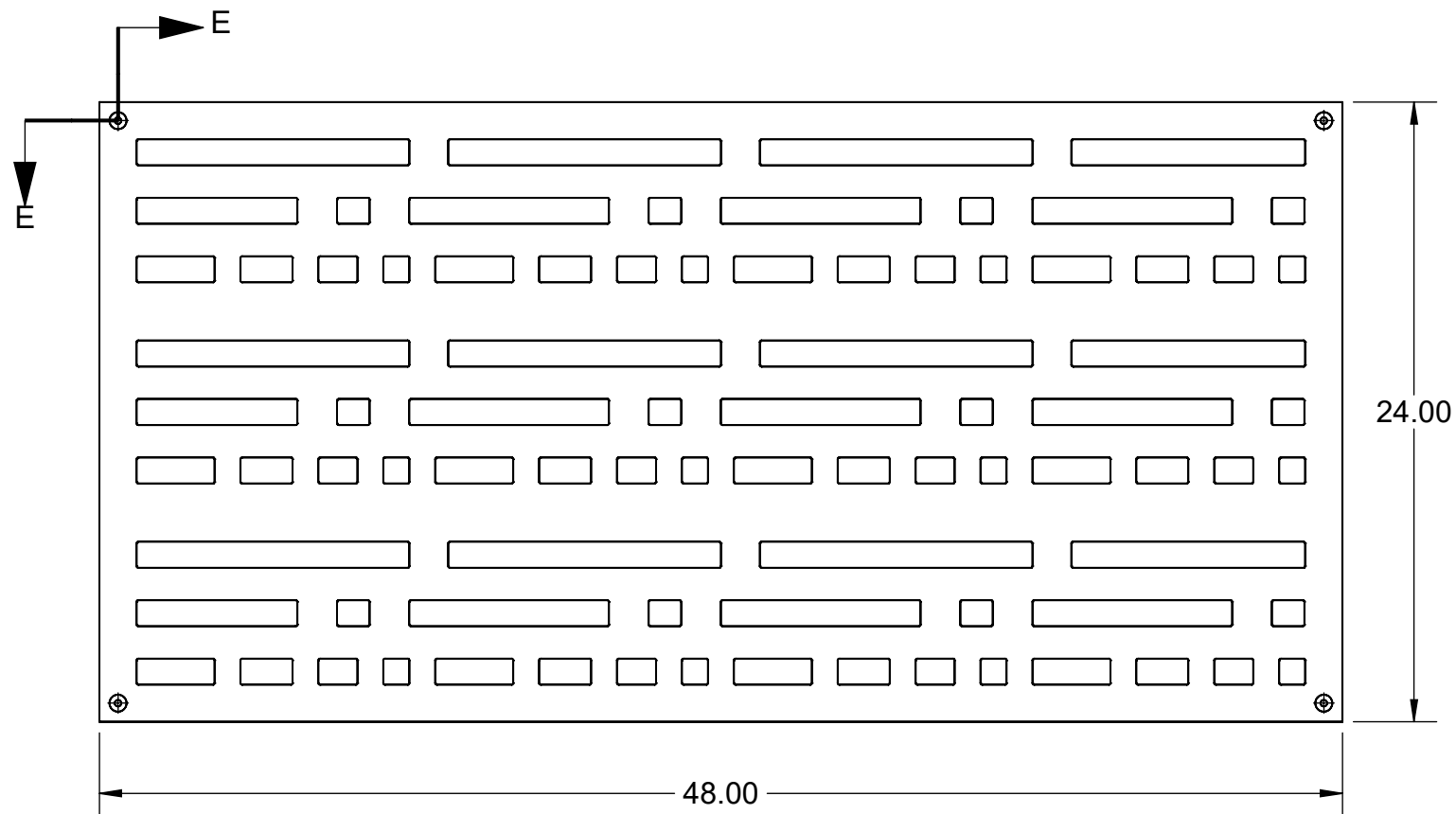
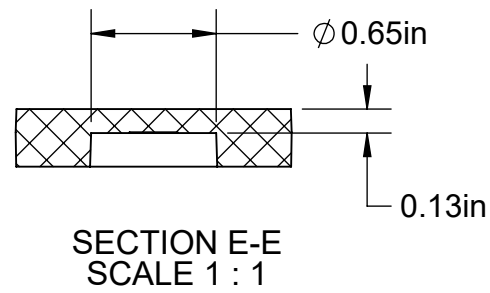



THE INFORMATION CONTAINED IN THIS DRAWING IS PROTECTED BY COPYRIGHT AND PATENT LAWS OF THE UNITED STATES AND OTHER COUNTRIES. ANY REPRODUCTION IN PART OR AS A WHOLE WITHOUT WRITTEN PERMISSION IS PROHIBITED.

		BARRETTE Outdoor Living	
DRAWN: RP	DATE: 10/15/2018	APPROVED:	
DESCRIPTION: MORSE DECORATIVE SCREEN PANEL 2'X4'			
SHEET 5 OF 7	REVISION	PART NUMBER	
SCALE 1:7		N/A	
WEIGHT: 9.67			

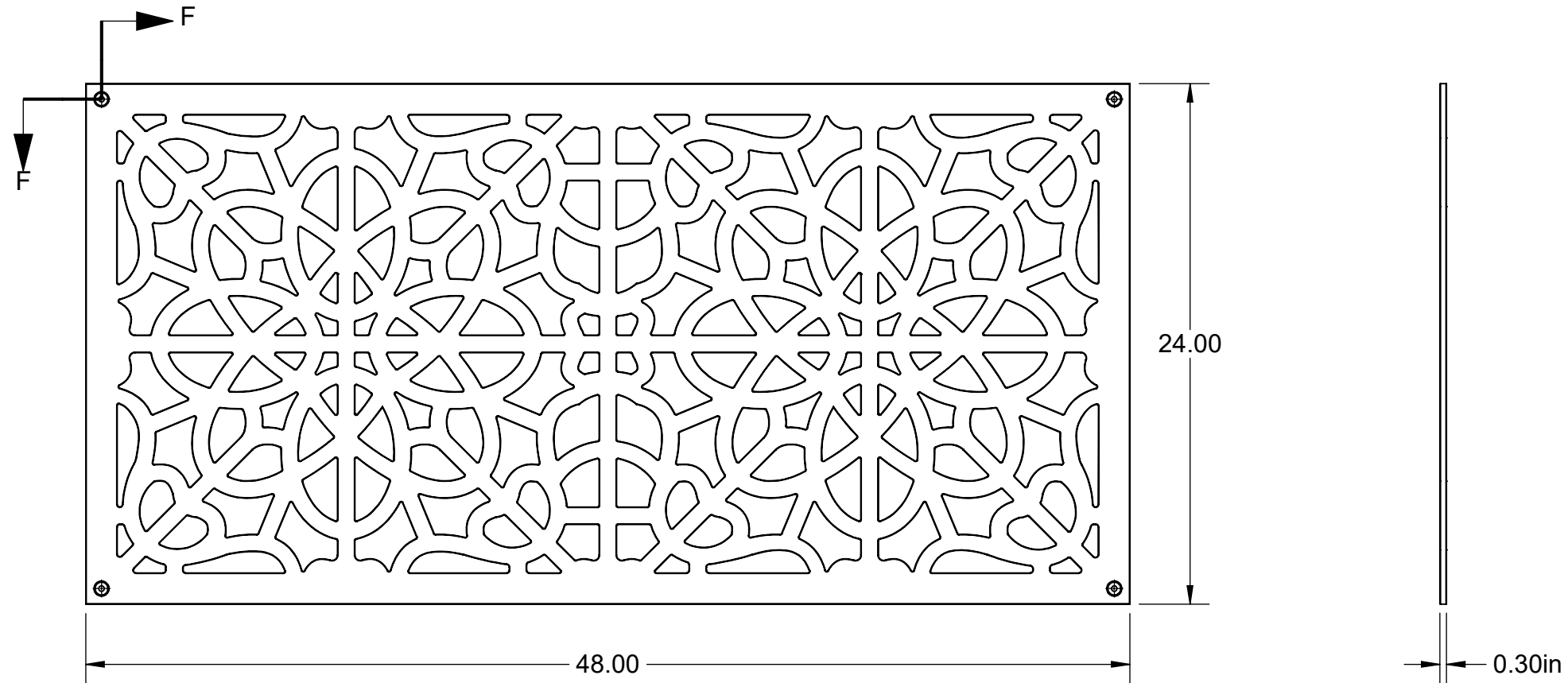
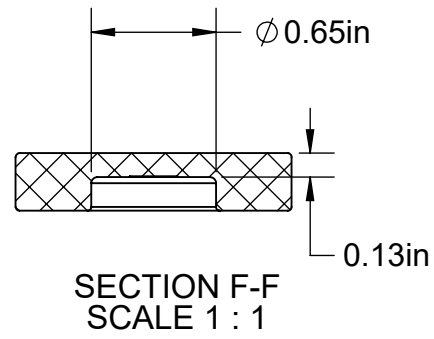
FRETWORK DECORATIVE SCREEN PANEL DETAILS



THE INFORMATION CONTAINED IN THIS DRAWING IS PROTECTED BY COPYRIGHT AND PATENT LAWS OF THE UNITED STATES AND OTHER COUNTRIES. ANY REPRODUCTION IN PART OR AS A WHOLE WITHOUT WRITTEN PERMISSION IS PROHIBITED.

		BARRETTE Outdoor Living	
DRAWN:	RP	DATE:	10/15/2018
DESCRIPTION:			
FRETWORK DECORATIVE SCREEN PANEL 2'X4'			
SHEET 6 OF 7	REVISION	PART NUMBER	N/A
SCALE 1:7			
WEIGHT: 8.61			

DECORATIVE SCREEN PANEL FRAME KIT DETAILS

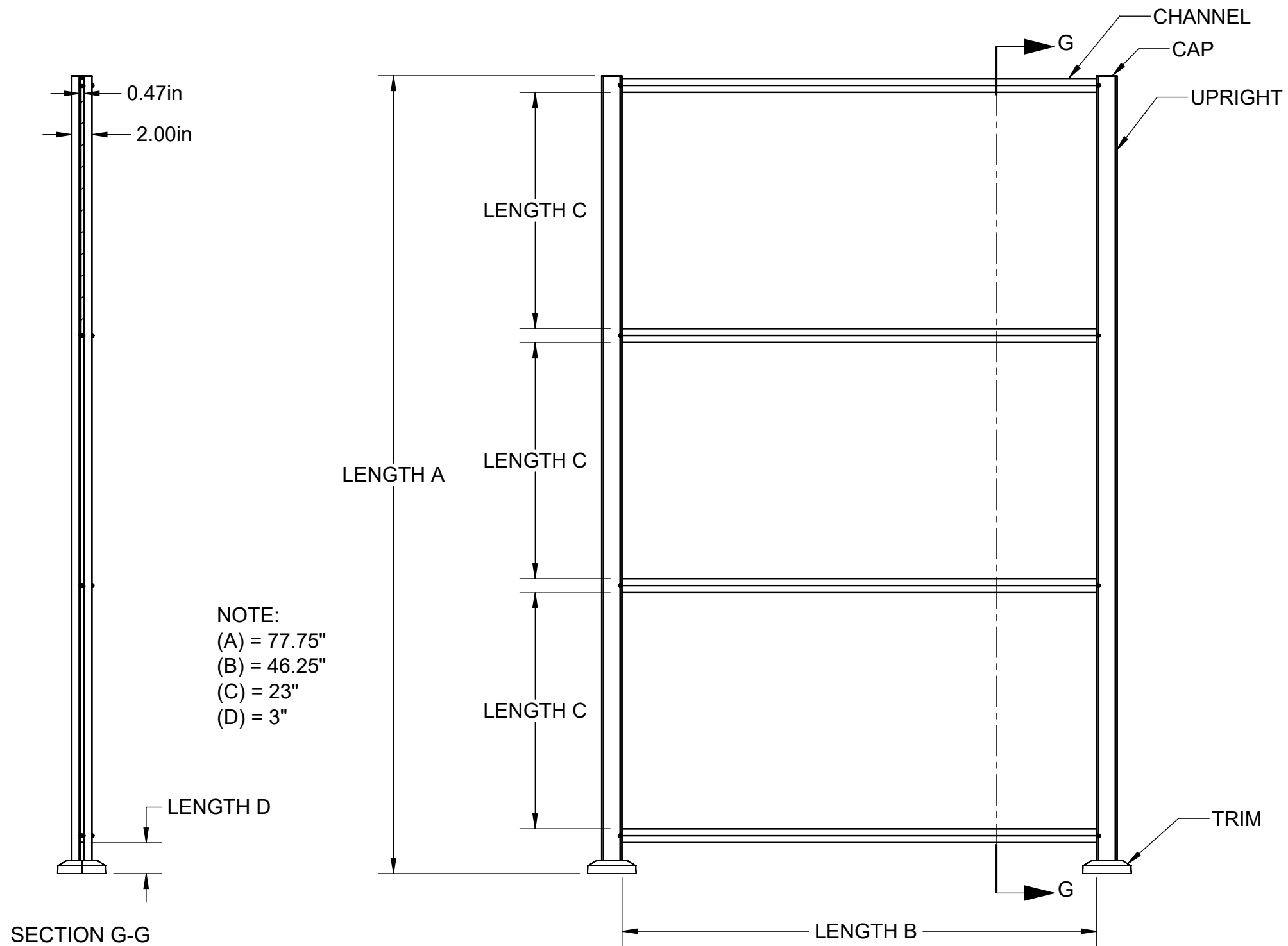

NOTE:
 (A) = 77.75"
 (B) = 46.25"
 (C) = 23"
 (D) = 3"

TOP AND BOTTOM CHANNEL

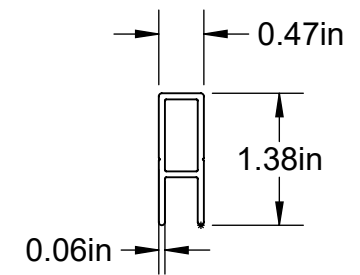

MID CHANNEL

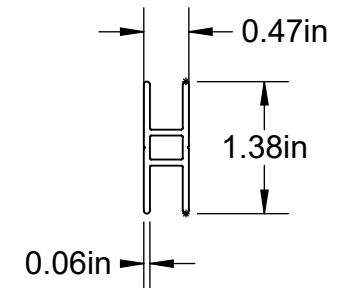

NOTE: DECORATIVE SCREEN PANEL KITS CAN HOLD 1-3 PANELS (SOLD SEPARATELY).

THE INFORMATION CONTAINED IN THIS DRAWING IS PROTECTED BY COPYRIGHT AND PATENT LAWS OF THE UNITED STATES AND OTHER COUNTRIES. ANY REPRODUCTION IN PART OR AS A WHOLE WITHOUT WRITTEN PERMISSION IS PROHIBITED.

		BARRETTE Outdoor Living
DRAWN:	RP	DATE: 11/17/2018
DESCRIPTION: DECORATIVE SCREEN PANEL KIT DETAILS		
SHEET 7 OF 7	REVISION	PART NUMBER
SCALE 1:12	0	N/A
WEIGHT:		